

XPD AC motor smart soft starter

Quick response, quality win.

[Http://www.wxwestpow.com.cn](http://www.wxwestpow.com.cn)

WUXI XIPUDA ELECTRONICS TECHNOLOGY CO.,LTD

Address: 905 Unit, No 367 Xihu Road, Wuxi city, Jiangsu province

Tel: +86 510 82832710, +86 510 82832750, +86 510 82832177

Fax: +86 510 82833826

After sales service hot line: +86 13812022918

[Http://wxwestpow.com](http://wxwestpow.com)

E-mail: root@wxwestpow.com wxzt2008@126.com

This instruction manual is subject to change without notice.

XPD soft start expert
Brand name products made in China

XPD AC motor smart soft starter
A-type instructions V3.0

WUXI XIPUDA ELECTRONICS TECHNOLOGY CO.,LTD

XPD soft start expert

CERTIFICATE

CCC CERTIFICATE FOR CHINA COMPULSORY PRODUCT CERTIFICATION

No. : 2014010304672994

NAME AND ADDRESS OF THE APPLICANT
Wuxi Xipuda Electronics Technology Co.,Ltd
NO.78, Xixian Road ,Jiang Xi Street ,New district,Wuxi

NAME AND ADDRESS OF THE MANUFACTURER
Wuxi Xipuda Electronics Technology Co.,Ltd
NO.78, Xixian Road ,Jiang Xi Street ,New district,Wuxi

NAME AND ADDRESS OF THE FACTORY
Wuxi Xipuda Electronics Technology Co.,Ltd
NO.78, Xixian Road ,Jiang Xi Street ,New district,Wuxi

NAME, MODEL AND SPECIFICATION
electric-motor softstarter

XP0008-3,XP0015-3,XP0022-3,XP0030-3,XP0037-3,XP0045-3,XP0055-3,XP0075-3
Ui:660V;Ith:15A,30A,45A,60A,75A,90A,110A,150A;
Ue:AC380V;Ie:15A,30A,45A,60A,75A,90A,110A,150A;AC-53b;3P

THE STANDARDS AND TECHNICAL REQUIREMENTS FOR THE PRODUCTS
GB 14048.6-2008

This is to certify that the above mentioned products have met the requirements of implementation rules for compulsory certification(REF No. CNCA-01C-011:2007).

Date of issue: Apr. 22, 2014 Date of expiry: Jan. 26, 2019

Validity of this certificate is subject to positive result of the regular follow up inspection by issuing certification body until the expiry date.

Date of original certification: Jan. 26, 2014

This certificate can be verified through CNCA's website: www.cnca.gov.cn

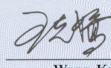
CCC President: 
Wang Kejiao
CHINA QUALITY CERTIFICATION CENTRE
Section 9, No.188, Nansihuan Xilu, Beijing 100070 P.R.China
http://www.cqc.com.cn

CHINA QUALITY CERTIFICATION CENTRE

Q 0919639

CHINA QUALITY CERTIFICATION CENTRE
CERTIFICATE OF CONFORMITY
Certificate No.: CE140307004333

Product electric-motor softstarter

Applicant Wuxi Xipuda Electronics Technology Co.,Ltd
NO.78, Xixian Road ,Jiang Xi Street ,New district,Wuxi

Type/model XP0008-3,XP0015-3,XP0022-3,XP0030-3,XP0037-3,XP0045-3,XP0055-3,XP0075-3

Technical data Ui:660V;Ith:15A,30A,45A,60A,75A,90A,110A,150A;
Ue:AC380V;Ie:15A,30A,45A,60A,75A,90A,110A,150A;AC-53b;3P

This is to certify that, on the basis of the tests undertaken as per Report No. 03601-A-13Y0060-S, the submitted sample of the above item complies with:
EN 60947-4-2:2000+A1:2002+A2:2006
and fulfill testing requirement of the European Directive:
2006/95/EC

Date of issue: Apr. 22, 2014
Date of expiry: Jan. 11, 2017

President: 

CE CHINA QUALITY CERTIFICATION CENTRE
Section 9, No.188, Nansihuan Xilu, Beijing 100070 P.R.China
http://www.cqc.com.cn

CE 0003053

恒标
HBQA

QUALITY MANAGEMENT SYSTEM
CERTIFICATE OF CONFORMITY

Registration No.: 06714Q10409R0M

This is to certify that the Quality Management System of:

Wuxi Xipu Da Electronic Technology Co., Ltd.
No.78 Qian Xi Xian Road, Jiang River Street Square, New Area, Wu Xi City, Jiangsu Province
Postcode: 214111

has been found to conform to Quality Management System Standard:
GB/T 19001-2008/ISO 9001:2008

This certificate is valid only to quality Management system certification related to the following product(s)/service(s):
Production and Service of Soft Starter Motor, Inverter Sales
(Deletion of Clause: 7.3)
Date of Issue: May.7.2014
Valid Date: May.7.2014 — May.6.2017

BEIJING HENGBIAO QUALITY CERTIFICATION CO.,LTD.
NO. 28, Zhongguancun South Ave, Haidian District, Beijing, P.R. China
General Manager: 

恒标 **IAF** **CNAS**
MANAGEMENT SYSTEM
CNAS C067-Q

IEC **TECEE** **CB** **SCHEME**

Ref. Certif. No.
CN30229

IEC SYSTEM FOR MUTUAL RECOGNITION OF TEST CERTIFICATES FOR ELECTRICAL EQUIPMENT (IECEE) / SYSTEME CEI D'ACCEPTATION MUTUELLE DE CERTIFICATS D'ESSAIS DES EQUIPEMENTS ELECTRIQUES (IECEE) METHODE OC

CB TEST CERTIFICATE

Product electric-motor softstarter

Name and address of the applicant Wuxi Xipuda Electronics Technology Co.,Ltd
NO.78, Xixian Road ,Jiang Xi Street ,New district,Wuxi

Name and address of the manufacturer Wuxi Xipuda Electronics Technology Co.,Ltd
NO.78, Xixian Road ,Jiang Xi Street ,New district,Wuxi

Name and address of the factory Wuxi Xipuda Electronics Technology Co.,Ltd
NO.78, Xixian Road ,Jiang Xi Street ,New district,Wuxi

Ui:660V;Ith:15A,30A,45A,60A,75A,90A,110A,150A; Ue:AC380V;Ie:15A,30A,45A,60A,75A,90A,110A,150A;AC-53b;3P

Model / Type Ref. XP0008-3,XP0015-3,XP0022-3,XP0030-3,XP0037-3,XP0045-3,XP0055-3,XP0075-3

PUBLICATION **EDITION**

IEC 60947-4-2:1999+A1:2001+A2:2006

03601-A-13CB0079-S

CHINA QUALITY CERTIFICATION CENTRE
Date: 2014-04-25
Signature: Wang Kejiao

Issued 2003-05
China Quality Certification Centre
Section 9, No.188, Nansihuan Xilu, Beijing 100070 P.R.China
Tel: +86-10-83886666
Fax: +86-10-83886282
website
www.cqc.com.cn

CB 0025338

Introduction

Thank you for using the XPD series A-type full digital AC motor smart soft starter produced by WUXI XIPUDA ELECTRONICS TECHNOLOGY CO.,LTD

In order to use the XPD series A-type smart soft starter correctly and guarantee security of the operator, please read this instruction manual carefully before using the smart soft starter. Please contact WUXI XIPUDA ELECTRONICS TECHNOLOGY CO.,LTD or local dealer if you find that there is no answer for problems occurred in operation, we will do our best to service you.

Safety notice

1. The smart soft starter shall be installed by specialized technical personnel or under the instructions of the specialized technical personnel;
2. The power and specifications of the load motor shall match with the smart soft starter as far as possible.
3. Never connect capacitors with the output terminals of the smart soft starter (U.V.W);
4. The connection of the input wire and output wire of the smart soft starter shall be wrapped by insulating tape.
5. The housing of the smart soft starter must be earthed reliably;
6. The input power supply must be switched off before maintaining the equipment;
7. The interior circuit board shall not be maintained by non-professional for there is high voltage of the interior circuit board.

Content

1. Functions and characteristics of XPD series A-type smart soft starter	1
1.1 Function.....	1
1.2 Characteristics	1
2. Model of product and inspection.....	1
3. Working conditions and installation	2
3.1 Working conditions	2
3.2 Installation requirements	3
4. Operating principle.....	4
5. Basic wiring and external connected terminal.....	5
5.1 Wiring of main circuit	5
5.2 Wiring of control circuit.....	5
5.2.1 Comparison table of exterior control terminals.....	6
5.2.2 Matters need attention in wiring of control circuit.....	6
5.3 Basic wiring diagram and exterior control terminal comparison table of XPD series A-type starter.....	7
6. Control mode and operating mode of XPD series A-type smart soft starter	7
6.1 Voltage-slope soft start control mode	8
6.2 Current limited soft start control mode	8
6.3 Jog operating control mode	8
6.4 Stop and control mode.....	9
6.5 Five operating modes of XPD series A-type smart soft starter	9
7. Function and description of operating keyboard	1
8. Query and set up parameters	2
8.1 Function, display mode and setting range	2
8.1.1 Note of Parameter setting	2
8.2 Parameter query.....	6
8.2.1 Query current rated current	6
8.2.2 The last failure query.....	6
8.3 Set up of parameter.....	6
8.3.1 Set up of starting mode.....	6
8.3.2 Set up of relevant parameters under voltage-slope start mode	7
8.3.3 Set up of relevant parameters under current limited starting mode.....	8
8.3.4 Set up of relevant parameters under jog operating mode	8
8.3.5 Set up of control method	9
9. Adjustment and set up of rated output current.....	10
10. Adjustment and set up of rated output current.....	10
11. Fault protection indication.....	10
11.1. Description of failure display and resolutions	11
12. Trial run.....	12
12.1 Inspection before operation	12
12.2 Power on and operation.....	12
12.3 Matters need attention and security in trial run	12
13. Specifications and model.....	13
14. Installation mode and overall dimension.....	14
15. Wiring diagram of control cabinet typical applicable to soft starter A-type.....	15
16. Product warranty card	15
17. Customer feedback form	16
18. Product information feedback	17

1. Functions and characteristics of XPD series A-type smart soft starter

XPD series A-type digital AC motor smart soft starter is a kind of new starting equipment ranged at international advanced level and produced by adopting electric power and electronic technology, microprocessor technology and lead control theory design. This product can limit starting current of the asynchronous motor in the starting effectively and can be used extensively in the loads of the blower fan, the water pump, the transportation device, and it is the idea product for generation changing of the reduced voltage starting equipment in traditional star/triangle conversion, auto-coupling voltage reduction, and magnetic control reduction voltage.

1.1 Function

Reduce starting current of the motor and decrease capacity of power distribution to avoid investment in the capacity increase.

Reduce starting stress and prolong service life of the motor and relevant equipments.

With Multi-starting mode, wide range current and voltage, the smart soft starter can adapt multi-loading condition and can improve technology.

Powerful and complete performance, guarantee the reliable operating of load equipment.

1.2 Characteristics

Starting mode

Different starting mode and parameter setting can be selected according to characteristics of the load. The softer starter can optimize the starting effect of the motor to the most extent.

High technology performance

The control circuit is simplified by adopting high performance microprocessor and powerful software support function. Consistent, accurate and quick speed of execution can be obtained without adjusting the circuit parameters.

High reliability

All electric elements of the XPD series A-type smart soft starter are filtrated strictly, and the master control board has been circle tested for 72 hours at high temperature and vibration tested, and thereby the high reliability of the product can be guaranteed.

Structure optimized

Unique compact modular structure and connecting mode of upper inlet wire and lower outlet wires make the starter more compact and it facilitate the integration and mating of starter.

Set up function of keyboard

Convenient and visualized operation display keyboard can be used to set up and modify the start, stop, operation and protection parameters according to different loads.

Functional description

The XPD series A-type smart soft starter can provide the motor with protective functions of open-phase, overload, over current, excess starting time and three phase current balance degree and so on. Build in 12v power supply, simulating 4-20mA current output, setting up the function of soft stop.

Rated power supply outputted

Actual output current of the smart soft starter can be adjusted within a certain range to make the actual output current of the smart soft starter match with the actual load current if the nominal power of the smart soft starter is larger than the actual load power, and thereby to guarantee the output power of the smart soft starter match with the actual load power.

2. Model of product and inspection

All functions and operation performance of each XPD series A-type smart soft starter have been tested

before leaving the factory. The user shall inspect the smart soft starter as per following procedures when received the smart soft starter, and please contact the supplier immediately when found there are any problems of the XPD smart soft starter.

Inspect nameplate of the product: make sure that the cargo you received is the product you had purchased.

西普达 XPD 系列电动机软启动器	
型号	XPD075A-3
输入电源	3Φ 380V AC 50Hz
适配电机	75KW
条形码	
出厂编号	
无锡西普达电子科技有限公司	

XPD series motor smart soft starter	
Model	
Input voltage	
Applicable motor	
Factory number	
Manufacture date	
WUXI XIPUDA ELECTRONICS TECHNOLOGY CO.,LTD	

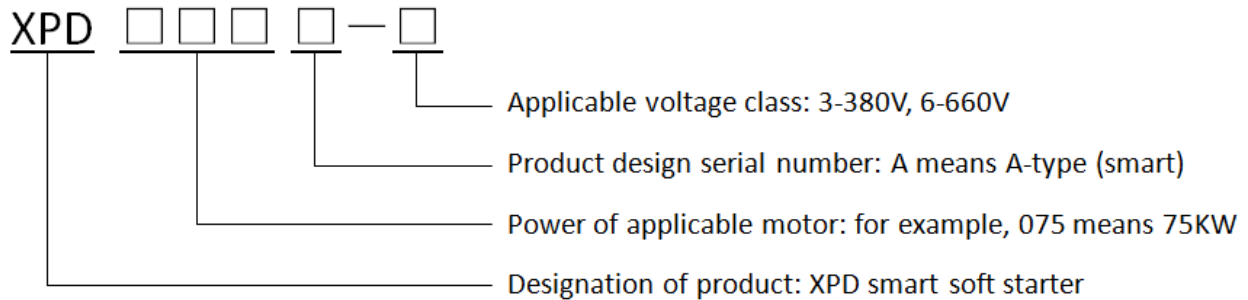

Inspect the product to see if it is suffered by those damages during transportation process: disconnection of internal parts, pit or distortion of the housing, disconnection of wire, etc.

Quality certificate and operating instructions: There are quality certificate and operating instructions inside each smart soft starter.

3. Working conditions and installation

3.1 Working conditions

Working conditions has important effect on normal operating life of the smart soft starter, so the smart soft starter shall be installed on the locations where meet requirements of following working conditions.

Working conditions of conventional product:

Power supply: commercial power, private station, diesel electric set

Three phases current: 380V (-20%, +15%), 50Hz

Applicable motor: general squirrel-cage asynchronous motor (winding motor may be applicable by negotiation);

Starting frequency: Recommended starting frequency of standard products shall be less than 15times/h (according to the load);

Type of cooling: natural air cooling for the starters of which the power is up to 75Kw, and forced-air cooling for the starters of which the power is more than 90Kw;

Working conditions: The XPD series A-type smart soft starter must be equipped with bypass contactor and necessary motor protective device in operation.

Protection level: IP20;

Ambient conditions: The capacity shall be reduced when using the starter at the elevation over 2000m;

Ambient temperature: -25 °C - 45 °C

Relative temperature: not exceed 95% (20+/-5°C), without condensation, without flammable and combusive and corrosive gas, without conductive dust. Indoor installation, well-ventilated. Shaken shall be less than 0.5G.

3.2 Installation requirements

The installation style of the XPD series A-type smart soft starter is wall hanging type, in order to guarantee the ventilation and heat dissipation of the equipments, the equipments shall be installed as per following requirements:

Installation orientation and space

In order to guarantee well ventilation and heat dissipation conditions of the XPD series A-type smart soft starter in operation, the smart soft starter shall be installed uprightly and sufficient heat dissipation space shall be set aside under and above the equipment, see figure 3-1.

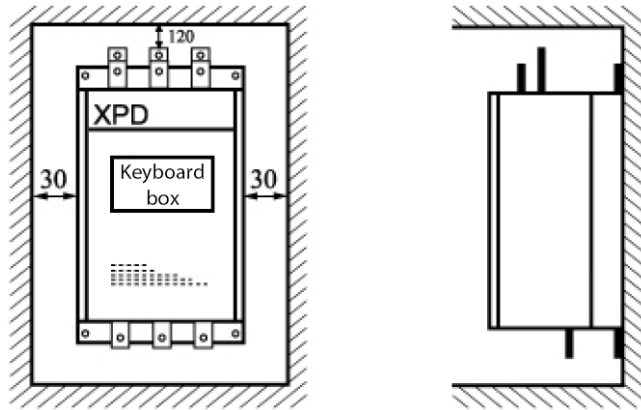

Figure 3-1 (wall hanging type)

Installed in the cabinet

Cabinet well ventilated shall be used when the XPD series A-type smart soft starter is installed in the power distributing cabinet. The starter can be installed in the cabinet in the arrangement of cross installation, see Figure 3-2. And installation of longitudinal arrangement can be adopted too, see Figure 3-3. However, a wind guiding spacer plate shall be added between the smart soft starters installed on the upper and lower to prevent the upper smart soft starter from being influenced by the heat from the lower smart soft starter, if installation of longitudinal arrangement is adopted (especially for the smart soft starter with forced-air cooling).

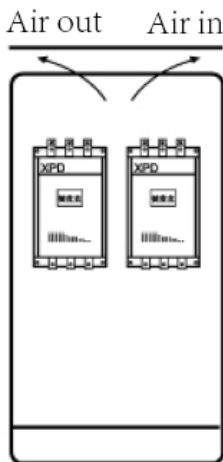

Figure 3-2 Installation of cross arrangement

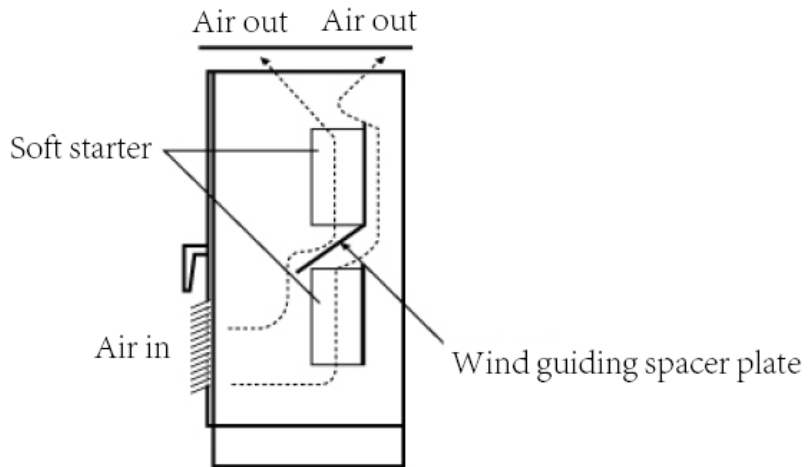

Figure 3-3 Installation of longitudinal arrangement

4. Operating principle

Three pairs of antiparalleled thyristors of the XPD series A-type smart soft starter are series connected in the circuit of the stator in the alternating current motor. As the thyristor has the function of electronic switch, a microprocessor is used to control the trigger angle of the thyristor to change the opening degree of it, and therefore the input voltage of the motor is changed and the soft starting of the motor is realized.

The output of the smart soft starter will reach the rated voltage after the starting is completed and the three-phase bypass contact KM will be controlled by output signal of bypass control to pull-in, and the motor will be connected with the electric network directed to operate, see Figure 4-1.

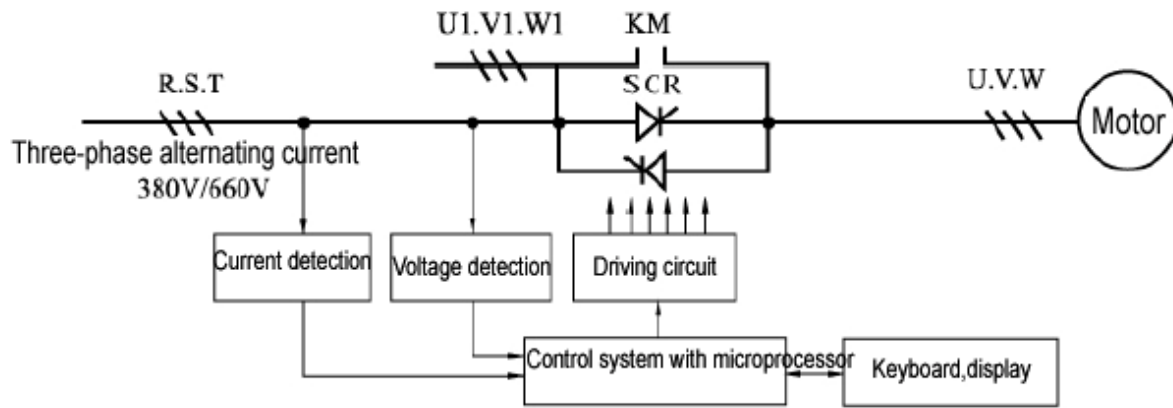

Figure 4-1

5. Basic wiring and external connected terminal

5.1 Wiring of main circuit

There are 9 wiring terminals in the main circuit of the XPD series A-type smart soft starter. And they are led out by the copper bars. The wiring method that use R.S.T as input terminals (connect with inlet power supply) is upper inlet wire mode and the wiring method that use U.V.W as output terminals (connect with the motor) is lower outlet wire mode, and U1.V1.W1 is upper outlet wire mode .The bypass contactors are bridged between the U1,V1,W1 and U, V, W.

5.2 Wiring of control circuit

There are exterior control interfaces pre-- set aside on the XPD series A-type smart soft starter, and see Figure 5-1 for detailed arrangement of 16 exterior wiring terminals. It can be used by consumer to realize external signal control and remote control.

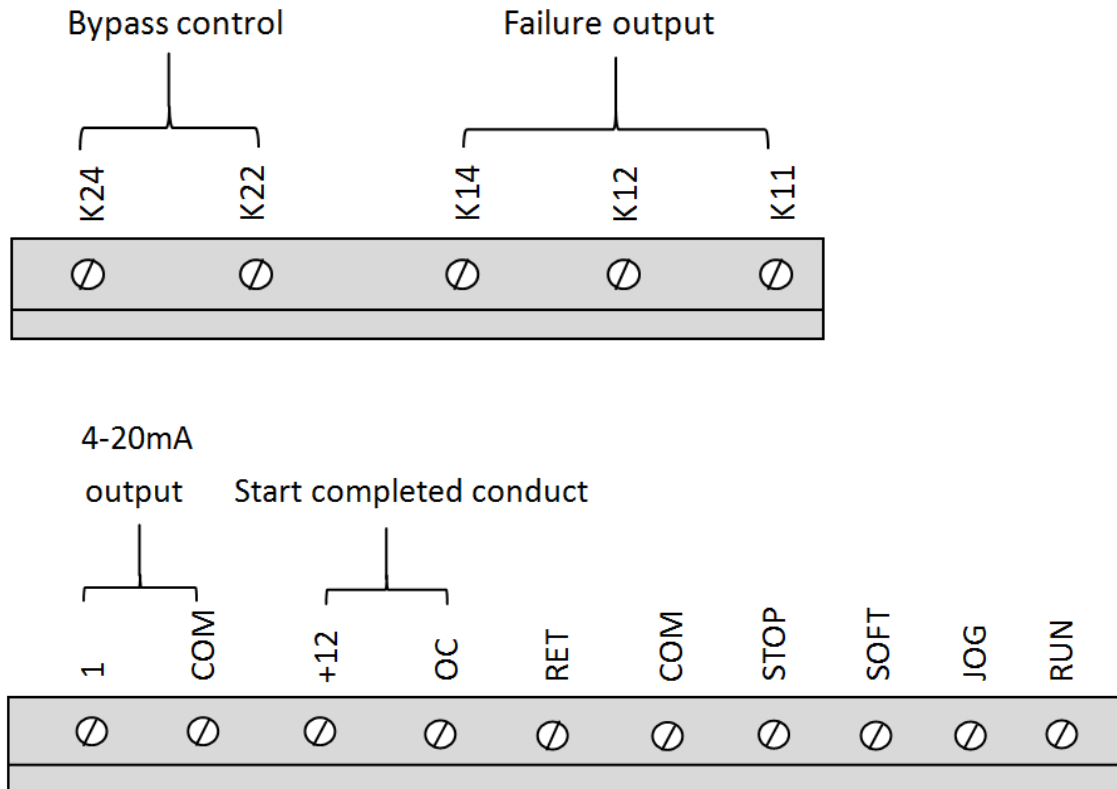

Figure 5-1

5.2.1 Comparison table of exterior control terminals

Table 5-1

Terminal description		Name of terminal		Description	
Main circuit	R.S.T	Input terminal of AC power supply		Connect with three-phase alternating current via circuit breaker (QF)	
	U.V.W	Output terminals of smart soft starter		Connect with three-phase asynchronous motor	
	U1.V1.W1	exterior bypass contactor terminals		The bypass contactors are bridged between the U1,V1,W1 and U, V, W.	
Control circuit	Digital input	RUN	Motor control terminal of external starting		External starting can be realized by short-circuit of the RUN and COM
		JOG	Motor control terminal of external jog		Jog can be realized by short-circuit of JOG and COM
		SOFT	External soft stop terminal		Soft shut-down can be realized by short-circuit of SOFT and COM
		STOP	Operational control terminal for stopping motor from exterior		External stop can be realized by short-circuit of STOP and COM
		COM	Common terminal of external control signal		Reference point of internal power supply
		RET	Exterior control reset terminal		Failure reset can be realized by short-circuit of RESET and COM
	Digital output	OC	Start to finish terminal		Conduct OC gate after start
		+12v	Internal power terminal		The internal output power of DC (12V,100mA)
	Analog output	COM	4-20mA output reference point		I_m : Motor output current (A) $I = 8 \times \frac{I_m}{I_e} + 4$ I_e : Motor rated current (A) I : (4-20mA) output current (mA)
		I	4-20mA output The load input impedance $\leq 400 \Omega$		
	Relay output	K14	Normally opened	Failure output terminal	K12-K14 closed when failure occurs K11-K12 are disconnected Contact capacity AC: 10A/250V DC:10A/30V
		K11	Normally closed		
		K12	Common		
		K24	Normally opened	Externally connect with the control terminal of bypass contactor	K24-k22 are closed after starting is completed K21-K22 are disconnected Contact capacity AC:10A/250V DC:10A/30V
		K21	Normally closed		
K22		Common			

★ Means there are two wiring methods for exterior control, see basic wiring diagram 5-2 for details.

5.2.2 Matters need attention in wiring of control circuit

1. The consumer can connect relevant wires with the exterior control terminals to realize remote control or to use the failure output terminals as alarm signal in the operation of the XPD series A-type smart soft starter. It

is needn't to connect the wires with the relevant exterior terminals if the consumer only use the keyboard of the equipment to control the motor and do not need to use the external signal. See Figure 5-1 for details.
 2. There are two wiring methods of the XPD series A-type smart soft starter for external starting and stop control, these are three-wire control wiring and two-wire control wiring, see Figure 5-2 for details.

5.3 Basic wiring diagram and exterior control terminal comparison

table of XPD series A-type starter



图5-2

Bypass control failure output
 Three-wire control two-wire control

* External control can be realized by using three-wire control and two-wire control mode, the starter is in starting state when the K is switched on and the starter is in stop state when the K is switched off under two-wire control mode.

Figure 5-2

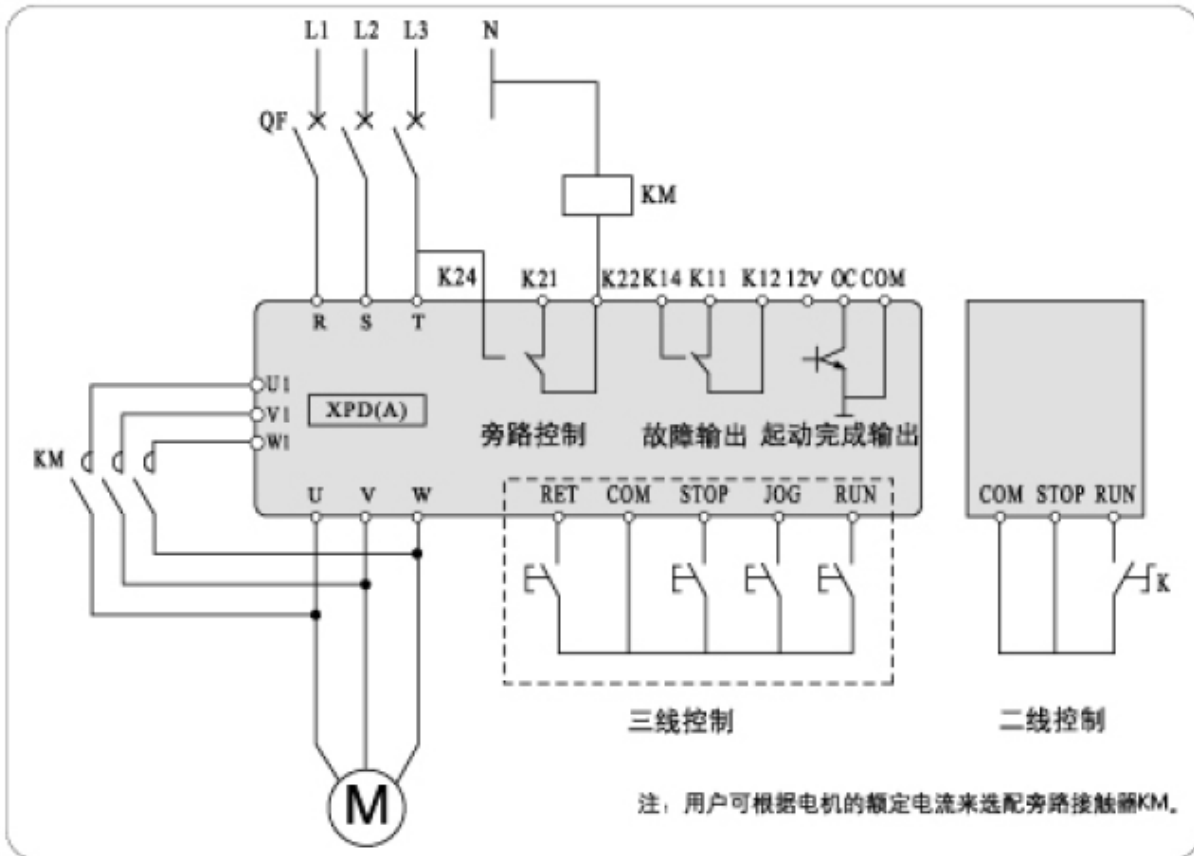
6. Control mode and operating mode of XPD series A-type smart soft starter

There are two starting modes of voltage-slope start and current limited start available as for the XPD series A-type starter. And there is also the jog operating function. The consumer can choose one of those three independent start modes according to different load and specific requirements.

6.1 Voltage-slope soft start control mode

Voltage variation oscillogram of voltage-slope start is shown in Figure 6-1, and U_0 is the initial voltage value outputted by the smart soft starter in the starting process. The output voltage of the smart soft starter rise quickly and come to U_0 when the motor is started, and then the output voltage of the smart soft starter will rise gradually in the time t_1 set, and the motor is accelerated continuously along with the rising of the voltage. The starting process is completed when the voltage reaches rated voltage U_e and the rated speed of the motor is reached. Both initial voltage U_0 and starting time t_1 can be set according to loading conditions, and the setting range of the U_0 is from 5% to 75% of the voltage of the electric network, and the setting range of the t_1 is from 1s to 120s.

Voltage-slope start is suitable the follow occasion, like large inertia load, not strict requirement at current and high stationarity at starting. This start mode can greatly reduce the start impact and machine stress. The initial voltage U_0 (the initial voltage applied on the motor) outputted by the smart soft starter at the instant of starting, and the initial starting torque of the motor will be larger if this value is higher, but instantaneous impact also be greater after start. The length of starting process is association with setting of start time, the weight of load, but nothing to do with current limiting magnification.

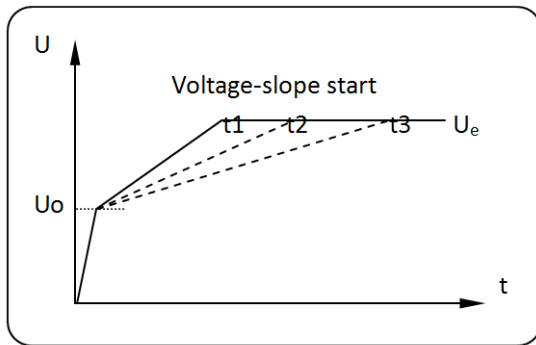

Figure 6-1

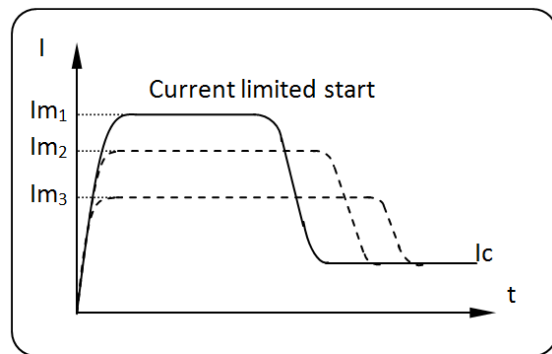

Figure 6-2

6.2 Current limited soft start control mode

Under the current limited starting mode, the output voltage value rise quickly in the start of the motor until the output current reaches the set amplitude limited current value I_m , and the starter hold this output current value at a point that is not higher than the current value I_m to make the motor to accelerate gradually, see Figure 6-2. The output current will descend to the rated current I_e quickly when the speed of the motor is approaching the rated speed, and then the starting process is completed. The amplitude limited current value can be set according to the actual load. And the setting range is from 20% to 400% of the rated current I_e of the motor.

Current limited mode is usually suitable such occasion, as strict requirement on current, especially the capacity of power grid is too small and need limiting the capacity of starting, and then set up the current limited multiple based on the requirement, normally between 2.5-3 times, if too small that will not be operated normally, if adapt the current limiting start, start-up time is related to current limiting multiple, the start-up time will be shorter if the current limiting multiple get larger, conversely start-up time will get longer.

6.3 Jog operating control mode

The output voltage of the smart soft starter is increased quickly to the jog voltage u_1 and is held at this point

under this control mode. The output torque (Figure 6-3) of the motor in jog operation can be changed by changing the set value of the u_1 , and this function is very useful to the trial run or orientation of some loads.

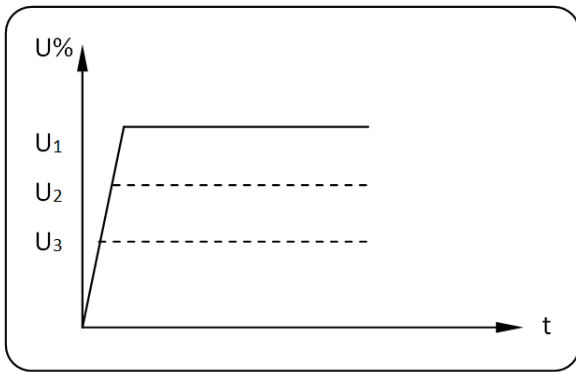

Figure 6-3

6.4 Stop and control mode

There are two stop modes of optional stop and soft stop for XPD A-type soft starter. Consumer can set up it according to the requirement of load and working condition.

Optional stop the soft starter will issue instructions to disconnect bypass contactor and blockade the output of the main circuit of thyristor after receiving the command of stop, and then the motor will stop freely by inertia.

Soft stop

6.5 Five operating modes of XPD series A-type smart soft starter

► Ready operating mode

The smart soft starter will carry out self checking when power on. The self checking include: Checkout parameters set up by the consumer (error protection of parameter setting), voltage phase judgment (open-phase protection) and temperature of the system (Smart soft starter overheating protection), etc. The system will enter into failure standby state if there are any failure occurs. The Smart soft starter will enter into the ready operating mode if the self checking is normal, and the **READY** mark is displayed on the keyboard panel. And the operating mode indicating light on the right side of the will indicate current starting control mode at the same time.

► Parameter setting operating mode

Press down and hold the PRG button for 5s or press PRG button and  button to make the smart soft starter enter into the parameter setting operating mode when the smart soft starter is under the ready operating mode. Each control parameters can be modified under this mode. See clause 8.3 parameter setting for details.

► Start operating mode

Press start key  when the smart soft starter is under the ready operating mode and the start-stop operating control mode is permitted, the smart soft starter will start the motor as per pre-set operating mode immediately, and display the starting current value on the keyboard at the same time.

The starting or operation of the motor will be terminated when press down stop button STOP at any time in starting procedure, and the starter will come back to the ready operating mode **READY**.

The system can continuously monitor those parameters such as the input voltage phase, the sudden heavy current (short circuit or motor locked rotor protection), the starting time (starting overload protection) and the temperature of the system (smart soft starter overheating protection) under this mode.

► Bypass operating mode

The normal opened terminals K22, K24 on the by-pass controller of the smart soft starter will be closed automatically after the smart soft starter start the motor successfully, and then those terminals are used to switch on the KM, the bypass contactor will connect the motor with the electric network and the motor will

operate normally, this indicate that motor start successfully and switch to the work condition of by-pass, and then set up the parameter as per Table 8-1  SCR trigger select after by-pass operating. The real-time working condition will be displayed on keyboard.

► **Failure protection mode**

The smart soft starter will enter into the failure protection mode and block input and output quickly if system finds that one of the parameters monitored exceeds specified value when the smart soft starter is under the starting mode, the operating mode or the ready operating mode, and the keyboard panel will display the failure code. See "Description of failure display and resolutions" for details of the failure codes.

7. Function and description of operating keyboard

There is an operating keyboard with digital display function for the XPD series A-type smart soft starter to realize the operation of the smart soft starter. These operations include: display the data, set up and store the parameters, query the data, failure protection display, failure reset, and start and stop the motor in time, etc. See Figure 7-1 for structure of the keyboard.



Figure 7-1

Functional description of buttons

There are five buttons on the keyboard box: **RUN** (start button), **STOP** (stop button), **PRG** (program button), **▲** (Increase button), **▼** (Decrease button).

RUN (start button): If the motor is under the ready operating mode **READY**, press this button to start the motor as per pre-set mode.

STOP (stop button): The motor will be stopped and the smart soft starter will be backed to the ready operating mode **READY** when pressing this button if the motor is under the starting mode or the operating mode; and the smart soft starter will quit the program mode of data modifying and store data modified when pressing down this button if the smart soft starter is under the program mode of data modifying, and then the smart soft starter will come back to the ready operating mode **READY**. The smart soft starter will be reset and come back to the ready operating mode **READY** by pressing down this button and hold for 5s if the smart soft starter is in failure state and the failure code is displayed.

PRG (program button): Press down this button and hold for 5s and the starter will enter into the program mode if the starter is under the ready operating mode; the page turning of the different data can be realized by pressing **PRG** button under the program mode.

▲ (Increase button): Press this button under the program mode to increase the data to be modified.

▼ (decrease button): Press this button under the program mode to decrease the data to be modified.

Note: 1. Under the program mode, all data modified will be stored automatically when either pressing the **PRG** button to turn page to the next function data code mode or pressing **STOP** button to quit program mode after the data are modified.

2. The keyboard of the A-type product can be removed and operated after the parameters are set if exterior control operation is used.

8. Functional parameter table and annotation

8.1 Functional parameter table

See following table 8-1 for parameters that can be set and modified and the setting range of the XPD series A-type smart soft starter

Function	Name	Setting range and meaning of parameter	Default value
F0	Starting mode selection (1)	1- Slope 2- Current limited 3-Jog	2- Current limited
F1	Slope initial voltage (2)	5%-75% of electric network voltage	30% (3)
F2	Jog voltage	5%-75% of electric network voltage	30s
F3	Slope starting time	1-120s	30s
F4	Starting current limited value	20%-400% of rated current of smart soft starter	300% (4)
F5	Limited time of current limited start	1-120s	30s
F6	Start-stop control method	400%-600% of rated current of smart soft starter	3
F7	Unsymmetry of current	5%-50% of operating current of smart soft starter	30
F8	Control method choice	1- Keyboard is available 2-exterior control is available 3- Both keyboard and exterior control are available	3
F9	SCR trigger select of by-pass operating	1.close SCR trigger 2.not close SCR trigger 3.close SCR trigger, display b-p(note 2)	2
L-	Start the overload level	1-8	4
P-	protecting value of operating over-current	20%-400% of rated current of smart soft starter	200
S-	Stop mode choice(note 1)	1 optional stop 2 soft stop(voltage-slope)	1
SF	Parameter of soft stop time	1-10	5
R	Indication of current rated current	See the 8.2 chapter	Nominal current on nameplate
E---	Failure display	See the 11chapter	
READY	Ready operating mode	Cannot be modified by consumer	

Note1: The parameter of “stop mode choice” is only available by keyboard operating, stop method will relation to wiring connecting if adapt the exterior control operating.

Note2: Soft starter will quit the monitor condition and display **b-P** under the by-pass operating and the **F9** value is 3

8.1.1 Annotation of Parameter setting

Choice of starting mode **F0**

There are 3 starting modes by setting the parameter on the keyboard for XPD A series soft starter. The choice and setting of parameter, please reference the description of table 8-1 and the 8chapter

Slope initial voltage F1

The unit is set only for voltage slope operating mode and indicates on the operating keyboard display V, % when setting this item. This parameter is mainly used to indicate the initial voltage U_0 (the initial voltage applied on the motor see pic6-1) outputted by the smart soft starter at the instant of starting, and the initial starting torque of the motor will be larger if this value is higher. The default value is set at 30%. It is not necessary to use large value for general load such as blower fan and pump. This value can be increased properly for the load with higher static resistance, but generally it is set between 25% and 50%.

Jog voltage F2

The setting range of the jog voltage under the jog operating mode is from 5% to 75%. The unit indication on the operating keyboard displays V, % when setting this item. The voltage outputted by the smart soft starter remain constant (is held at set value) under the jog operating mode. Motor not operating under the voltage of jog operating mode (setting value is low) is normal. The choice and setting of the parameter, please reference the description of pic 6-3 and table 8-1.

Slope starting time F3

This parameter is mainly used to reflect the time interval from the beginning of the starting to the end of the starting when using the voltage-slope start mode and the default value is set for 30s. The unit indication on the operating keyboard display S when setting this item. This parameter means: the smart soft starter will enter into protection mode automatically if delaying 3 seconds after the starting time gets the setting time and the starting current is still less than 125% of the current rated current under the current limited starting mode. This value can be set according to the property of the load and it shall be increased properly for heavy duty or load with large inertia (the starting time of motor getting rated speed will be less than the set up time when the load is light and it is normal if the starting can be completed successfully). It is invalid under the limited current starting.

Starting current limited value F4

This parameter can be used to set the maximum current limited value of the starting current under the current limited starting mode, the setting range of the current limited value is from 20% to 400%, and the default value is 300%. It means that the starting current is 3 times than the rated current of the motor and can meet starting requirements of general load such as the blower fan and the pump (the unit indication on the operating keyboard displays A, % when setting this item). This value can also be adjusted according to the property of other loads, and generally the adjustment ranged from 250% to 350% is preferred. It will be invalid under the slope voltage starting mode.

Limited time of current F5

The setting range of the limited time of current limited start is from 1 to 120s, (the unit indication on the operating keyboard displays S when setting this item). This parameter means: the smart soft starter will enter into protection mode automatically if the starting time exceed limited time and the starting current is still greater than 125% of the current rated current under the current limited starting mode

Protecting value of stop/start current F6

This parameter is set for protecting the motor if the start current was too large, the setting range from 400-600%, it means that the protecting current is 4-6 times to rated current. (default value is 400). This value can be increased as per practical situation, when the inertia load of start is large.

Current unbalancedness F7

This parameter is set for protecting motor when the deviation of three phase current is too large during the motor starting and operating, default value is 30%. The sensitivity of three phase unbalancedness will be higher if the value gets smaller during the operating. The value can't be set too small, because too high sensitivity of three phase current will affect the normal use of motor.

Note: The three phase current protecting function is available only under the operating current (three phase mean) is larger 20% than rate current

Computational formula for current unbalancedness as follow:

$$\text{Unbalancedness: } \Delta I\% = (I_{\max} - I_{\min}) / I_{\text{aver}}$$

$$\text{Note: } I_{\text{aver}} = (I_a + I_b + I_c) / 3$$

Choice of control method: F8

The switch between the keyboard operation and exterior control operation can be realized by modifying the parameters, and the default is 3, keyboard operation mode are both available..

The keyboard starting operation is unavailable when the wiring of the exterior control terminal is the

two-wire control method.

Choice of SCR trigger bypass **F9**

This parameter can reflect the work condition of main circuit thyristor under the bypass operating and motor starting.

- 1.-----Shut down SCR trigger after bypass operating, now it is protecting condition and keyboard will display the operating current.
- 2.----- Not shut down SCR trigger after bypass operating, now it is protecting condition and keyboard will display the operating current.
- 3.----- Shut down SCR trigger after bypass operating, and then the keyboard will display “b-p” (no protection function) default value is 2 (not shut down trigger pulse of thyristor after bypass operating)

Starting overload level **L-**

The overload protection function is set for start process, which is divided into 8 level and have different protection time of each level. Please reference details of relation between overload multiples of each level and protection act time on 8.1.2 chapter. The default value is 4 (corresponding IEC60947-4-2 standard 15 levels) it can't choose, if overload protection is inverse time character after bypass operating.

Operating current protection value **P-**

This parameter is set for protecting motor once the current excess normal value suddenly for some reason. The max over current can be modified under the motor operating if we change the value of the parameter, the default value is 200%, it means the protecting value of over current is 2 times than rate value.

Choice of stop mode **S-**

This parameter including two stop mode, optional stop and soft stop. The default value is 1—optional stop. (soft stop mode is mainly for water pump type load which prone to hammer effect during stop process. And the optional stop is mainly used for the normal load.

Soft stop time parameter **SF**

This parameter is set for soft stop, Which reflect the soft stop time and the soft stop effect of motor. Setting corresponding time parameter value will get placidly soft stop under the different load.

8.1.2. Soft starter overload protection and protection levels

Overload protection function will appear during the starting and operating process of soft starter of XPD series A type

Starting overload divided into 8 levels, the default value is 4 (corresponding IEC60947-4-2 standard 15 levels) .it can choose the setting according to load, the level lower, the protection time will be shorter, conversely will be longer.

Operating load is 2 level(corresponding IEC60947-4-2 standard 10A levels), this parameter is non-optional, please reference the details from curve graph and form as follow:

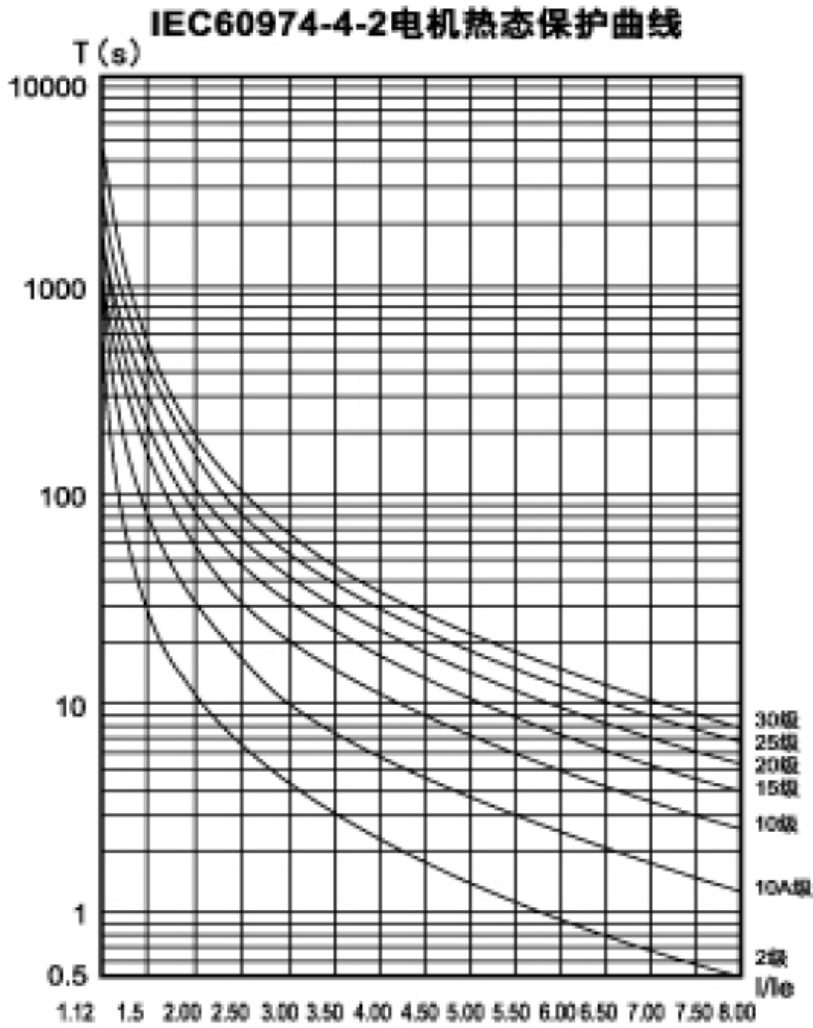



IEC60947-4-2 Motor thermal state protection curve

Overload multiples / Overload level	Corresponding Standard level IEC60947-4-2	5Ie	4Ie	3Ie	2Ie	1.5Ie	1.2Ie	1.05Ie
1	2 grade	1.5s	2.5s	4.5s	13s	35s	180s	---
2	10A grade	4 s	6s	12s	30s	80s	460s	---
3	10 grade	8 s	13s	23s	60s	180s	800s	---
4	15 grade	12s	18s	32s	90s	230s	1200s	---
5	20 grade	16s	25s	46s	130s	320s	1650s	---
6	25 grade	18s	30s	58s	170s	520s	2200s	---
7	30 grade	23s	36s	68s	190s	650s	2800s	---
8	Special grade	28s	45s	82s	224s	---	---	---

8.2 Parameter query

8.2.1 Query current rated current



Press down  button when the smart soft starter is under the ready operating mode  , the keyboard will display function code  , the current rated current value and data unit amperes (A) immediately. The system will come back to the ready operating mode when release the button.

For example: When the current rated current of soft start is of 150A.



Figure 8-1

8.2.2 The last failure query

Press down  button and hold for 5s when the smart soft starter is under the ready operating mode  , and the keyboard display the last failure code .The system will come back to the ready operating mode when release the button.





For example: The last failure is open-phase







Figure 8-2

8.3 Set up of parameter

8.3.1 Set up of starting mode

Press  button and hold for 5s (or press down  and  button at the same time) when the smart soft starter is under the ready operating mode  , and then the smart soft starter will enter into the starting mode selection mode  . And then the required "starting mode code" can be selected by

using the  and  button. The "slope mode" indicating light  on the left upper side of the operating keyboard will be illuminated when the "1" (voltage-slope start mode) is selected; the "current

limited mode" indicating light  on the left upper side of the operating keyboard will be illuminated when the "2" (current limited mode) is selected, and the indicating lights on the left upper side of the operating keyboard will not be illuminated when the "3" (jog operating mode) is selected.

Press  button again after the start operating mode selected is acknowledged to set up relevant parameters of current starting mode selected.

For example:

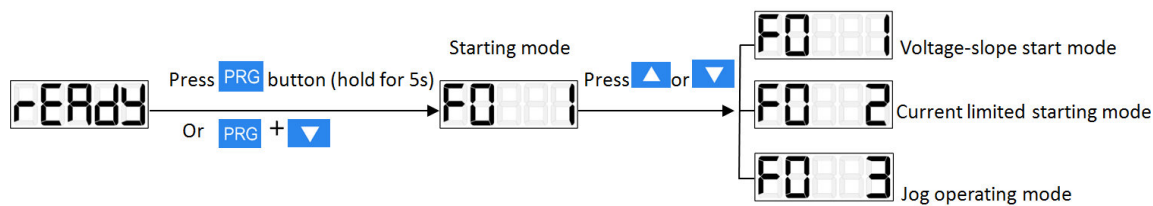

Figure 8-3

Note: As for the set up of starting mode: There are 3 modes for the A-type smart soft starter, and usually the voltage-slope start mode and the current limited starting mode are used and the consumer can select starting mode according to specific load. Two modes can be used for general load; however, as for the large inertia load it is prefer to use the voltage-slope start mode. The default of the starting mode when leaving the factory is **F0:02**, the current limited starting mode.

8.3.2 Set up of relevant parameters under voltage-slope start mode

The procedures for set up relevant parameters after the voltage-slope start operating mode is selected are as follows:

For example:



图8-4

Voltage-slope mode Press PRG Slope initial voltage percentage
Slope starting time Start-stop control method Press ▲ or ▼

In Figure 8-4:

Note:

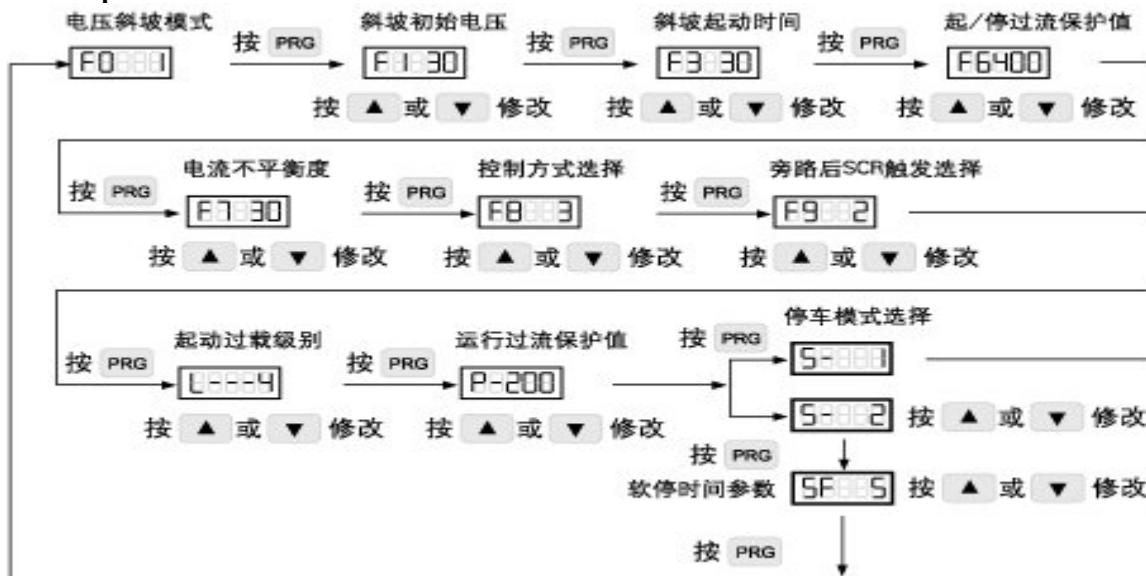
1. the new modified data will be saved automatically, if the data is confirmed when the all parameters are modified, no matter pressing PRG button PRG to turn page, or pressing button STOP to back to be ready for work condition **rEArdY**.

2. Pressing button STOP will be back to be ready for work condition **rEArdY**, no matter at any display parameter during process of modifying the parameter.

8.3.3 Set up of relevant parameters under current limited starting mode

The procedures for setting relevant parameters after the current limited starting mode was selected are as follows:

For example:



图8-5

- Current limited starting mode
- Starting current limited value percentage
- Current limited starting time
- Start-stop control method
- Press PRG
- Press ▲ or ▼

In Figure 8-5:

Note:

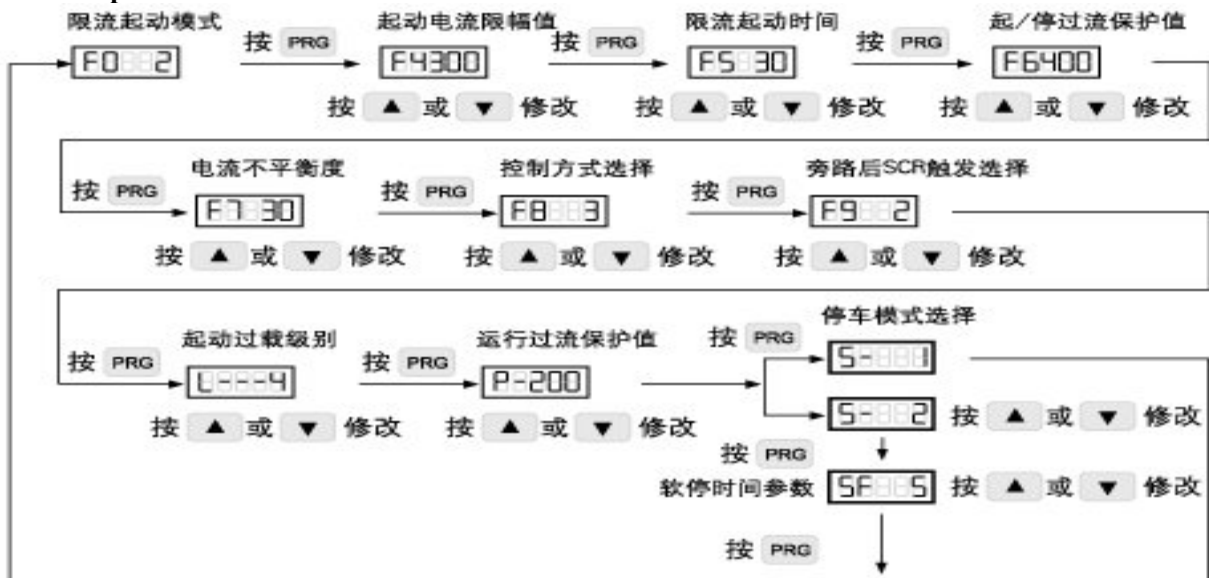
1. the new modified data will be saved automatically, if the data is confirmed when the all parameters are modified, no matter pressing PRG button PRG to turn page, or pressing button STOP to back to be ready for work condition **READY**.
2. Pressing button STOP will be back to be ready for work condition **READY**, no matter at any display parameter during process of modifying the parameter.

8.3.4 Set up of relevant parameters under jog operating mode

Generally, the jog operating mode is used in the contraposition of the equipments, the judgment of the positive and reverse rotation and the balance test of the three-phase current in the operating procedure. The three-phase voltage outputted by smart soft starter is remained constant in jog operation. The procedures for set up relevant parameters after the jog operating mode is selected are as follows:

For example:



图8-6

Jog operating mode
 Jog voltage percentage
 Start-stop control method
 Press PRG
 Press ▲ or ▼

In Figure 8-6:

Note:

1.the new modified data will be saved automatically, if the date is confirmed when the all parameters are modified, no matter pressing PRG button PRG to turn page, or pressing button STOP to back to be ready for work condition **rEAdy**.

2. Pressing button STOP will be back to be ready for work condition **rEAdy**, no matter at any display parameter during process of modifying the parameter.

8.3.5 Set up of control method

Start and stop of the XPD series A-type smart soft starter can be realized by using either the keyboard button or exterior button via its exterior control interface. The consumer can select set up according to requirements under either starting mode (see Figure 8-4, Figure 8-5, Figure 8-6).Use ▲ or ▼ button to select control mode you need after coming into **F8:01**.

For example:



图8-7

Selecting of control method
 press ▲ or ▼
 Neither keyboard nor external control is unavailable
 Keyboard is available
 External control is available
 Both keyboard and external control are available
 Press PRG
 Figure 8-7

Note:

1.the new modified data will be saved automatically, if the date is confirmed when the all parameters are modified, no matter pressing PRG button PRG to turn page, or pressing button STOP to back to be ready for work condition **rEAdy**.

2. Pressing button STOP will be back to be ready for work condition **rEAdy**, no matter at any display parameter during process of modifying the parameter.

9. Adjustment and set up of rated output current

The starting current limited value of the starter can be decreased to realize new matching if the power of the motor driven by the starter is less than the nominal power value on the nameplate of the smart soft starter, and thereby the starting effect of the motor driven and the accuracy of the failure protection function can be guaranteed. Modification method is connecting the reset terminal RET with terminal COM before energizing of soft starter, keyboard will display **PR 388** after energizing, and then within 5 seconds press **PRG** on the keyboard and hold it until display the default value of rated current on the keyboard, and now the **▲** or **▼** button can be used to modify current value displayed on the keyboard, when it finished. Press **STOP** and hold for 5 seconds, the system will be back to ready work condition, and save the modified current value at meantime, and the rated current will also change to be the modified current. The short-link line between RET and COM should be get rid off after the parameter modified already.

Note: now the rated current only adjust based on the nominal current, download adjustment.

Adjusting range: 50-100% Ie.

For example: change the output rated current 150A to be 75A. As following figure



图 8-8

10. Adjustment and set up of rated output current

The current value displayed of each XPD smart soft starter A-type has been calibrated during the debugging when leaving the factory. The current value displayed on the keyboard can be calibrated again if the consumer finds that there are any error between the actual current and the current value displayed on the keyboard during operation.

Action1: Set the starting mode at Jog operating mode, apply appropriate load on the motor, set the jog initial voltage at a value up to 40%, press RUN button and hold (the motor come into jog operating mode), press PRG button at the same time, and now the **▲** or **▼** button can be used to modify current value displayed on the keyboard, Make this value equal to the actual current. Release the RUN button and PRG button after modification, and then the current parameter modified will be stored automatically.

Action2: press RUN + **▲** or RUN + **▼** to modify the value of the current under the bypass work condition, and make this value equal to the actual current.











11. Fault protection indication

There are 11 kinds of protection function of XPD A type soft starter. Soft starter will stop once the fault protection function operating, and user can solve the problem based on the code of fault protection which be displayed on the keyboard. Setting reset by using extra control“reset terminal RET”or pressing stop and hold it for 5 seconds on the keyboard after troubleshooting. Soft starter also can reset by power on after the outage

Details reference form 11-1

11.1. Description of failure display and resolutions

Form 11-1

Fault code	Code description	Fault cause	Solution
	Parameter fault protection	Setting parameter is lost?	Examine all the parameters and reset
	Default phase protection	Coil in default phase? Power output of soft starter default phase?	Examine the coil in and output of soft starter
	Locked-rotor over current protection	Excess electricity at starting instant?	Examine the load condition The initial voltage is too high Starting limited Current is too high
	Soft start over heating protection	The inside of radiator overheating	Whether the radiator is normal? Whether bypass contactor is connected reliably
	Overrun of soft starting time	Load is too high? Or starting time is too short?	Examine the condition of load Or delay the starting time Or the limited current
	Over load protection	Whether operating under overload?	Examine the load current whether overrun
	Operating over current protection	Load increase suddenly? Fluctuation of load is too large?	Adjust the load operation condition
	Current unbalancedness protection	Motor problem? The value of current unbalancedness is too small?	Examine the motor condition Or reset the unbalancedness of current
	starting over current protection	Starting current excess the limited current	Adjust the limited current according to load or adjust the current protection
	Soft stop over current protection	Stopping current excess the limited current?	Adjust the current limit according to load Or adjust current protection Or adjust parameter of soft stop time

	Interference protection	External disturbance	Remove inference source Shell should be useful earthing
---	-------------------------	----------------------	--

12. Trial run

12.1 Inspection before operation

In order to guarantee safety operation, following items shall be followed to inspect the system before power on.

- ▲Is the power of the smart soft starter match with the power of the motor?
- ▲Does the insulation of the motor meet the requirements?
- ▲Are the input and output wiring of the main circuit correct?
- ▲Are all nuts of wiring tightened?
- ▲Are wiring of the bypass contactor correct?
- ▲Are there any short circuit phenomena when using the multimeter to inspect three-phase inlet power supply (R. S. T.)?

12.2 Power on and operation

▲It means normal when the keyboard display starting ready condition  under the soft starter power on. Two indicator light are used to indicate the start mode of soft starter (the voltage slope type and current limited type) and can be chose as per actual load.

▲Press button RUN (under the default value) to start the motor under the normal condition and the keyboard will display the actual current of motor starting or bypass operating. Press button STOP (under default value) to stop the motor under the motor operating, and then the soft starter will be back to ready condition .

▲XPD A type soft starter also can start and stop operating trial as above method under the output terminal U.V.W not connecting with motor., thereby preliminary test whether it is correct of system operating, the secondary control circuit wiring of bypass contactor switch and all kinds of indicator light and so on.

12.3 Matters need attention and security in trial run

- ▶The failure protection codes will be displayed if the failure protection is activated during whole power on process and operation procedure, see "form 11-1" for details and the relevant prompts shall be followed to handle the matters.
- ▶Do not open the housing of the smart soft starter after power on to avoid electric shock.
- ▶The starter and the motor shall be switched off immediately during the trial run to find out the problems if there are any abnormal phenomena such as abnormal sound, smoke or peculiar smell.
- ▶There are induced voltage on the three-phase U.V.W when the smart soft starter is switched on while the outputs of the smart soft starter are not connected with the motor. This is the normal phenomenon and the induced voltage will disappear after the outputs of the smart soft starter are connected with the motor.

13. Specifications and model

Table 12-1

Applicable power of motor	380V series	
	Rated current	XPD series A-type
7.5	18	XPD008A-3
11	22	XPD011A-3
15	30	XPD015A-3
18.5	37	XPD018A-3
22	45	XPD022B-3
30	60	XPD030A-3
37	75	XPD037A-3
45	90	XPD045A-3
55	110	XPD055A-3
75	150	XPD075A-3
90	180	XPD090A-3
110	220	XPD110A-3
132	260	XPD132A-3
160	320	XPD160A-3
187	365	XPD187A-3
200	400	XPD200A-3
220	440	XPD220A-3
250	480	XPD250A-3
280	550	XPD280A-3
320	620	XPD320A-3
400	720	XPD400A-3
450	850	XPD450A-3
500	1000	XPD500A-3

Ordering instructions

- ▶ Please notify the supplier of the model, specifications, loading conditions and operating conditions of the product in ordering for selecting the products correctly.
- ▶ The XPD series A-type products shall be equipped with the bypass contactor in operation. It should be noticed before purchasing, if you need forced air cooling.
- ▶ As for consumers with particular operating conditions or requirements, those special operating conditions or requirements shall be specified to the supplier and we will do our best to offer sound service.

14. Installation mode and overall dimension

规格及型号	适配电机 功率 (KW)	额定 电流 (A)	外型尺寸 (mm)			安装尺寸 (mm)						铜排尺寸 (mm)				重量 (kg)	安装 方式
			W1	H1	D	W2	H2	D1	D2	D3	d	W3	W4	D4	d1		
XPD008A-3	7.5	15	206	322	195	146	298	142	76	33	φ6	63	63	2	φ9	7.5	壁 挂 式
XPD011A-3	11	22	206	322	195	146	298	142	76	33	φ6	63	63	2	φ9	7.5	
XPD015A-3	15	30	206	322	195	146	298	142	76	33	φ6	63	63	2	φ9	7.5	
XPD018A-3	18.5	37	206	322	195	146	298	142	76	33	φ6	63	63	2	φ9	7.5	
XPD022A-3	22	45	206	322	195	146	298	142	76	33	φ6	63	63	2	φ9	7.5	
XPD030A-3	30	60	206	322	195	146	298	142	76	33	φ6	63	63	2	φ9	7.5	
XPD037A-3	37	75	206	322	195	146	298	142	76	33	φ6	63	63	2	φ9	8.5	
XPD045A-3	45	90	206	322	195	146	298	142	76	33	φ6	63	63	2	φ9	8.5	
XPD055A-3	55	110	206	322	195	146	298	142	76	33	φ6	63	63	3	φ9	9.5	
XPD075A-3	75	150	206	322	195	146	298	142	76	33	φ6	63	63	3	φ9	9.5	
XPD090A-3	90	180	260	463	213	231	429	140	55	40	φ9	78	30	5	φ11	22.5	
XPD110A-3	110	220	260	463	213	231	429	140	55	40	φ9	78	30	5	φ11	22.5	
XPD132A-3	132	260	260	463	213	231	429	140	55	40	φ9	78	30	5	φ11	22.5	
XPD160A-3	160	320	260	463	213	231	429	140	55	40	φ9	78	30	5	φ11	22.5	
XPD187A-3	187	365	300	490	242	270	457	165	55	40	φ9	91	40	5	φ11	28	
XPD200A-3	200	400	300	490	242	270	457	165	55	40	φ9	91	40	5	φ11	28	
XPD220A-3	220	440	300	490	242	270	457	165	55	40	φ9	91	40	5	φ11	28	
XPD250A-3	250	480	300	490	242	270	457	165	55	40	φ9	91	40	5	φ11	28	
XPD280A-3	280	550	300	490	242	270	457	165	55	40	φ9	91	40	5	φ11	28	
XPD320A-3	320	620	300	490	242	270	457	165	55	40	φ9	91	40	5	φ11	28	
XPD400A-3	400	720	472	530	306	400	486	232	105	60	φ11	150	50	6	φ11	56	
XPD450A-3	450	850	472	530	306	400	486	232	105	60	φ11	150	50	6	φ11	56	
XPD500A-3	500	1000	472	530	306	400	486	232	105	60	φ11	150	50	6	φ11	56	

Wall hanging type Figure

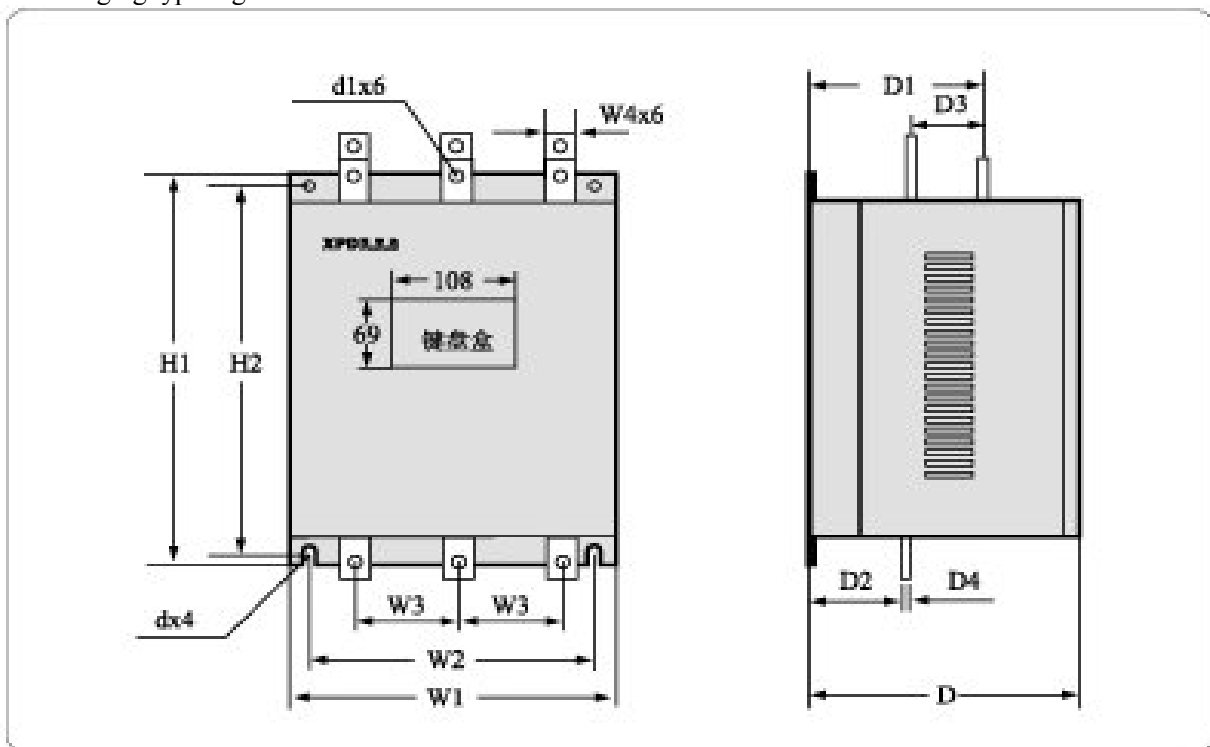

Keyboard box

15. Wiring diagram of control cabinet typical applicable to soft starter A-type



图10-1

- Fuse
- Start-stop of smart soft starter
- Bypass control
- Run indication
- Stop indicator
- Failure
- Main circuit
- Control circuit
- Output signal

Note: 90KW-500KW whole set of application drawing

For the drive capability of the interior relay contact K22 and K24 of the smart soft starter are limited, it is needed to use the intermediate relay JC to control winding of the bypass contactor as for the smart soft starter with power of 90KW and above.

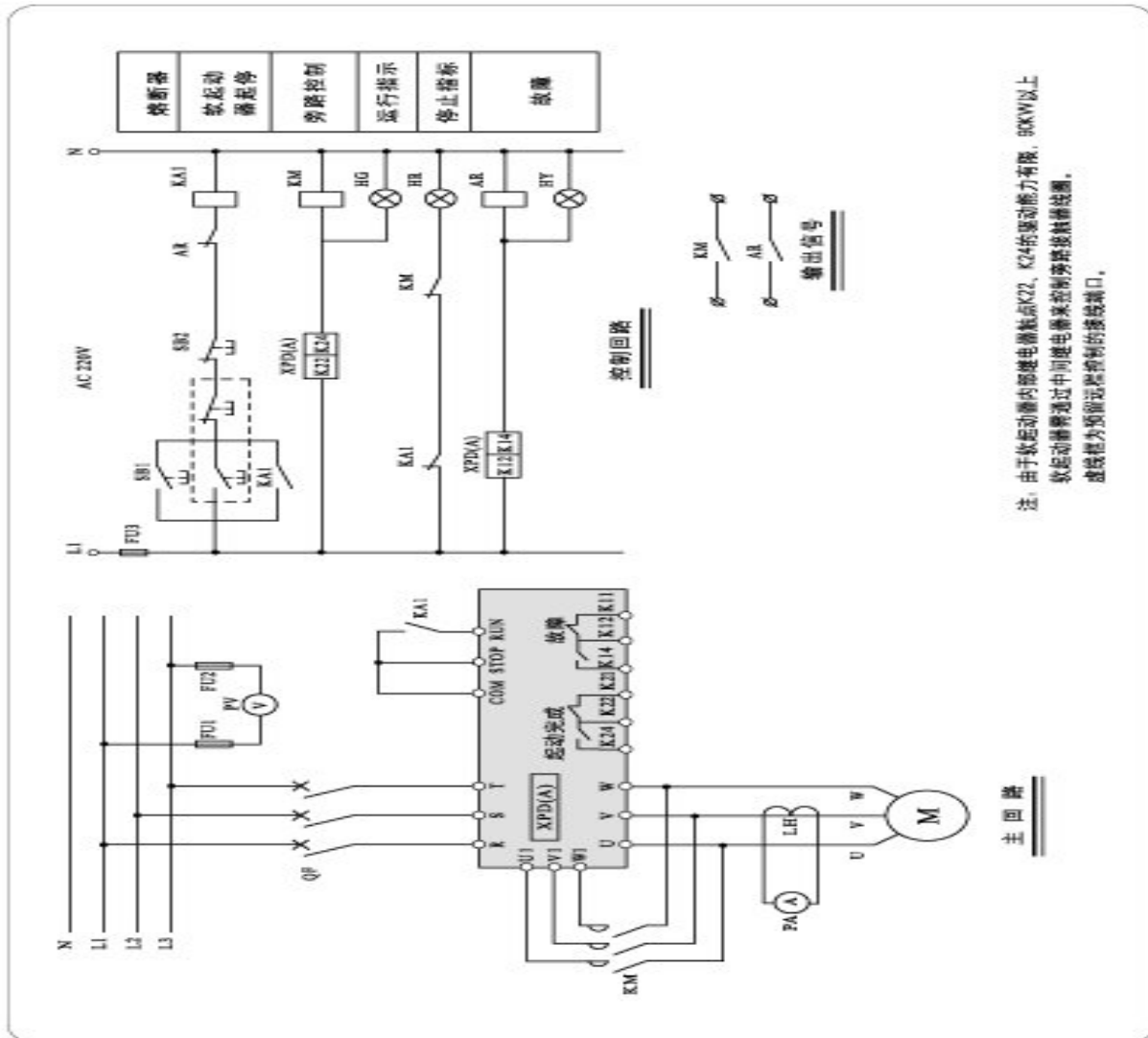
16. Product warranty card

Sincerely thanks for your purchasing products of Xipuda Electronics Technology Company!

This product has passed the strict quality inspection by our company. According to this card warranty, All

caused by the product itself quality problem in the normal use of failure, As long as during the warranty period, we will be responsible for free maintenance.

Product Type:	manufacturing number:
Warranty period:	
Purchasing date:	year month day
Invoice number:	
User name: (or company name)	
Address:	
Postcode:	Tel: Fax:
Dealer name:	
Address:	
Postcode:	Tel: Fax:
Dealer stamp:	

17. Customer feedback form

Honorific customers: for the convenience of better service for you, please fill out the form below:

The load and The control

Motor power and number of poles		Motor rated current		Normal work frequency range	
Load type					
Control mode					
Fault phenomenon					
Fault time	<input type="checkbox"/> Electric jump on fault <input type="checkbox"/> Malfunction jump <input type="checkbox"/> Run for a period of time of failure <input type="checkbox"/> Jump start failure				
Fault type					
Circuit board failure	<input type="checkbox"/> Electricity no display <input type="checkbox"/> Electricity smoke <input type="checkbox"/> Relay don' t pick-up				
Keyboard failure	<input type="checkbox"/> The key failure <input type="checkbox"/> parameters cannot be modified <input type="checkbox"/> Display lack of pen				
Abnormal output	<input type="checkbox"/> Non voltage output <input type="checkbox"/> Output voltage imbalance <input type="checkbox"/> High vibration of motor <input type="checkbox"/> Translate power abnormally from motor				
If the problem is not above column, please describe below:					
Fault description:					

18. Product information feedback

Honorable customers:

Thanks for your concerning and purchasing our products of XIPUDA ELECTRONICS TECHNOLOGY,LTD。 for better service, we kindly hope to get the information about you and the product which you purchase, that for learning about your further requirement and getting your precious feedback。 for the convenience of getting our service, please visit our company website: <http://www.wxwestpow.com.cn>

1. Download the updated product introduction
2. Refer to all kinds of technical data of products, such as usage, specification and performance, common problem and so on
3. Product application case sharing
4. Technical problems consulting and feedback online
5. Tell us the use information and customer demand information by email
6. Query the latest products, receiving all kinds of warranty and extend additional services

Record